





<p>(K) × 2</p>  <p>φ10x42mm</p>	<p>(L) × 2</p>  <p>M6x60mm</p>	<p>(M) × 6</p>  <p>φ8x35mm</p>	<p>(N) × 6</p>  <p>M5x50mm</p>	<p>(G) × 2</p> 	<h1>OKYA60</h1>
---	---	---	---	--	-----------------



1

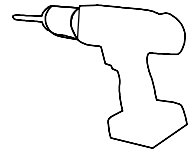
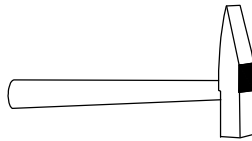
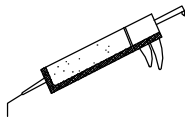
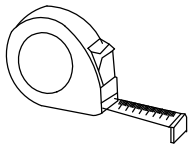
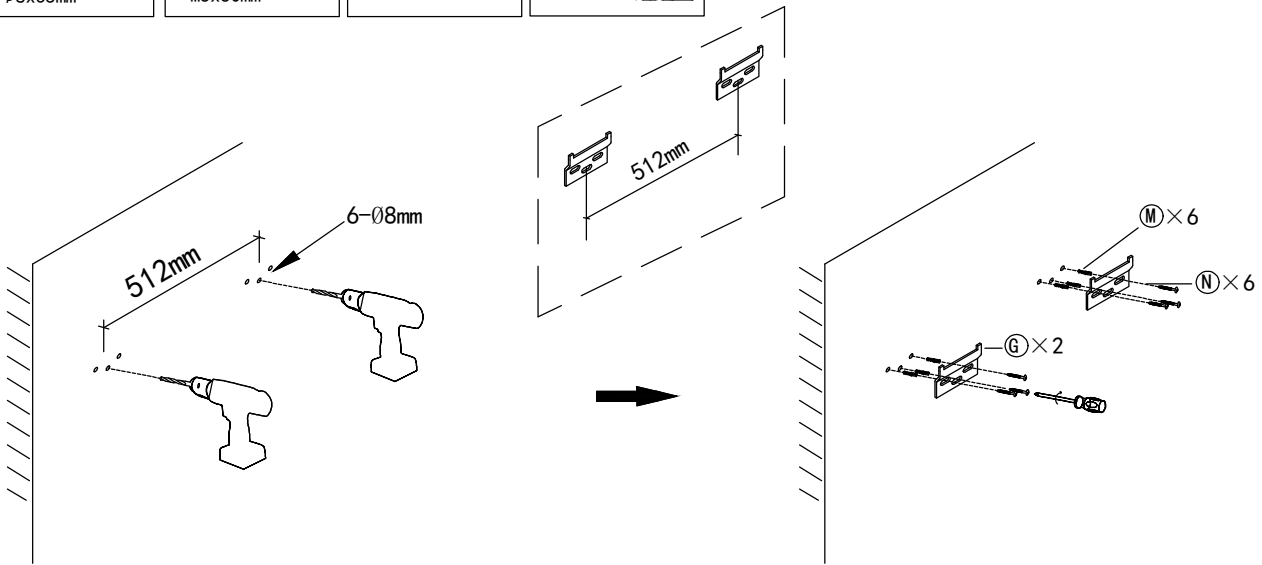
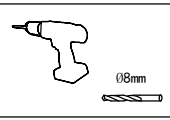
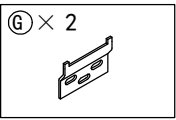
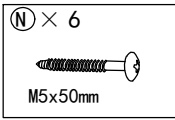
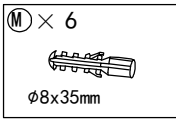

2

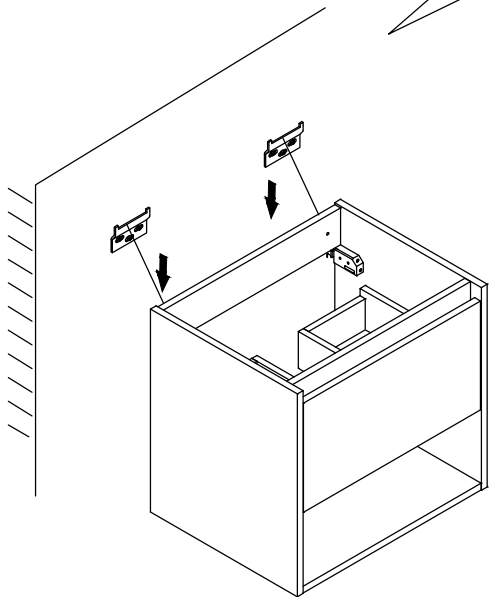
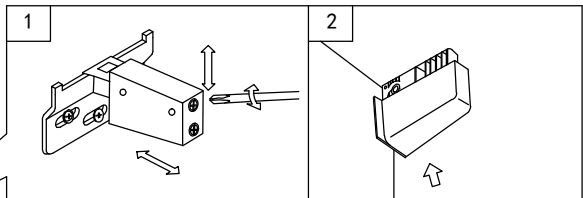
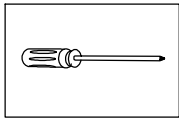

3

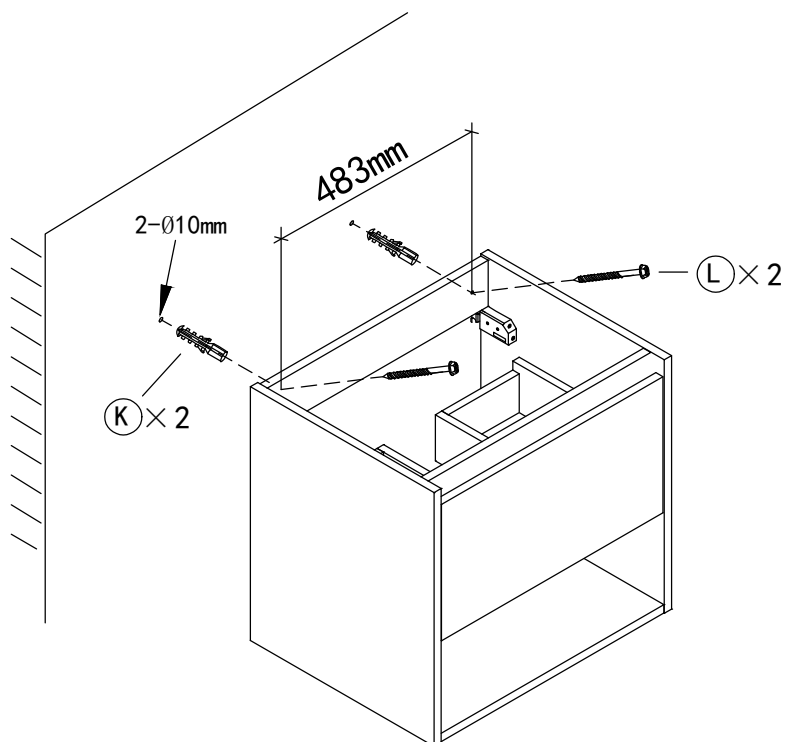
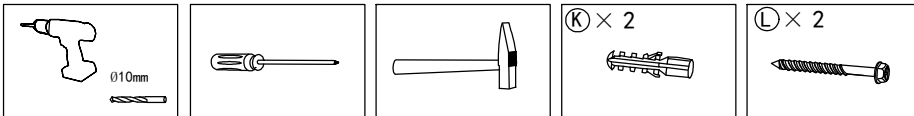

4

